

SpanSet secutex®

02

Lifting  
Buffer pad  
Lifting equipment

---

## BUFFER PAD

---

### Modes of action

---

---

## secutex - buffer pad Special properties and highly versatile.

A significant proportion of a product's total costs are attributable to damage resulting from a lack of buffer pad. The principal causes of this are carelessness, negligence and improper handling. This represents avoidable damage to goods and stock. However, staff absenteeism due to accident or noise-induced hearing loss is a cost factor that is easily overlooked; but which significantly reduces profits. secutex will enable you to reduce unnecessary costs and remove sources of danger.

### The advantages

- Safety at work for the user
- Reliable workflow
- Secure handling speeds up workflow
- Less materials damage
- Guaranteed compliance with

statutory requirements secutex is an excellent polyurethane elastomer with a particularly advantageous combination of physical and chemical properties.

### High structural strength

secutex offers extremely high tensile strength compared to other chemical materials. This enables the secutex material to be stretched to 500% of its original length without breaking.

### High flexibility

secutex offers considerably greater flexibility in comparison to conventional rubber. secutex retains its flexibility even under extreme temperature fluctuations.

### Extreme wear resistance

secutex is virtually indestructible. In wet wear resistance tests secutex performed better than many metals.

---

## The modes of action

---

### Damping effect

Where forces collide, materials are often unintentionally damaged. Impact damage to goods and stock often occurs due to carelessness, negligence, recklessness, improper handling or a lack of protection. secutex - buffer pad has a damping effect everywhere where products can be damaged under their own weight or during handling. In addition, foam coatings and hollow sections, which deform under loading, increase the damping effect, such as, for example, in secutex - Soft, secutex - SoftPad and secutex - Hollow Profile.

---

### Noise-reducing effect

Around 60% of all occupational illnesses can be attributed to noise. Even short peaks above 140 db or more sustained noise of 70 db can cause long-term damage to hearing. secutex - buffer pad dampens the impact of falling materials and other sources of noise at contacting surfaces. This prevents noise from being produced in the first place. The expensive insulation of equipment is no longer necessary.

---

### Anti-slip effect

secutex prevents loads from slipping and slipping off during transport. In tests, secutex scored higher than all comparable materials. secutex not only meets the standard, it exceeds the friction coefficient values standard currently in force. For wet or oily surfaces we recommend secutex with textured surfaces. Direct material contact is thereby re-established.

---

### Long-term effect

secutex - buffer pad is extremely resistant to abrasion. Extreme cutting resistance ensures extra-long service lives. With high pressure loading and flexing we recommend the use of harder materials. secutex combined with fabric or fibre glass reinforcement exhibits an even greater wear resistance than secutex without reinforcement.

---

## Collision protection

secutex collision protection can be used anywhere sturdy and long-lasting bumper protection is required.



Collision protection for shelving



Stainless steel collision protection [food industry]



Collision protection for cement pile

---

## Coil storage

Various standards and special solutions are available for the storage of coils and split bands.



Coil mat with handles

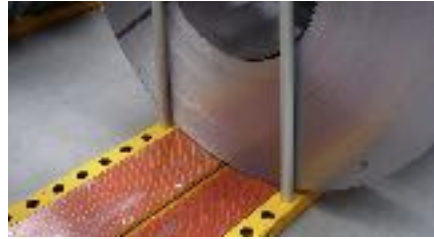

Coilprotect Semi with marker poles



Coil mat with end cap

---

## Buffer pad

Thanks to its various versions and degrees of hardness, buffer pad is suitable for installation in machinery and maintenance sector



Lining for pipe raising systems

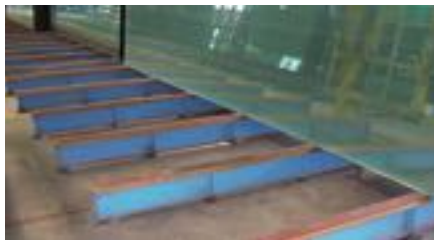

Support protection for glass frames



Coating for Bale clamps

---

## Rolls

With secutex, rolls, screws and rollers can be coated for use in transportation within the processing chain.



Heat-resistant and slit feeding rolls



Guide and pressure rolls with exchangeable cores



Rollers for the transport of sensitive profiles

---

## Fork protection

Fork and mandrel coatings for the safe and careful transport of sensitive goods.



Coatings for fork arms and fork backs



Soft backs with attachments slits



Pipe modules for forklift mandrels





## BUFFER PAD

### Different surfaces und technische Daten

 **Smooth**  
This surface is used for secutex - buffer pad applications where there is no water or oil between the load and the buffer pad. When dry, the smooth surface is slip-resistant.

 **Ground**  
The surface is slightly roughened. It is used where the buffer pad only comes into contact with fluids. The rough surface remains slip-resistant.

 **Fabric**  
In the case of fabric, the surface of the buffer pad is very rough. This is important if it continuously comes into contact with oil and water. The high degree of roughness ensures a durable non-slip finish.

 **Pyramids**  
Buffer pad with this surface is used predominantly for anti-slip protection on flooring.

### Long lifetime

secutex- yellow with hydrolysis stabiliser can be exposed to all weather. If secutex is used in safety-relevant areas, coordination with the manufacturer is necessary.

Shore A hardness [Allowance ± 5°]	secutex 75°	secutex-yellow 55°	secutex-yellow 75°	secutex-yellow 90°	Norm
Friction coefficient	0,3 - 0,4 μ	0,3 - 0,4 μ	0,3 - 0,4 μ	0,15 - 0,25 μ	
Hydrolysis stabilised	no	yes	yes	yes	
Density	1,22 g/cm <sup>3</sup>	1,21 g/cm <sup>3</sup>	1,22 g/cm <sup>3</sup>	1,23 g/cm <sup>3</sup>	DIN 53505
<b>Tension</b>					
100% stretch	6,5 N/mm <sup>2</sup>	1,15 N/mm <sup>2</sup>	3,32 N/mm <sup>2</sup>	5,25 N/mm <sup>2</sup>	DIN 53504
300% stretch	9,5 N/mm <sup>2</sup>	1,65 N/mm <sup>2</sup>	5,25 N/mm <sup>2</sup>	8,29 N/mm <sup>2</sup>	DIN 53504
Breaking tension	37,5 N/mm <sup>2</sup>	19,5 N/mm <sup>2</sup>	34,2 N/mm <sup>2</sup>	38,5 N/mm <sup>2</sup>	DIN 53504
Tear resistance	27 N/mm <sup>2</sup>	15,8 N/mm <sup>2</sup>	35,0 N/mm <sup>2</sup>	55,2 N/mm <sup>2</sup>	DIN 53515
Rebound capacity	40 %	61,5 %	40,4 %	30,4 %	DIN 53515
Wear	50 mg	21 mg	35 mg	36 mg	DIN 53516
<b>Compression set test</b>					
72 h at 23°C, 25% compression	11,40 %	55,1 %	9,1 %	41,6 %	DIN 53517
24 h at 70°C, 25% compression	29,40 %	19,9 %	8,9 %	10,0 %	DIN 53517
Operating temperature*	-40 °C bis 100 °C	-20 °C bis 80 °C	-20 °C bis 80 °C	-20 °C bis 80 °C	DIN 53457
Surface resistance	10 <sup>10</sup> -10 <sup>13</sup>	10 <sup>10</sup> -10 <sup>13</sup>	10 <sup>10</sup> -10 <sup>13</sup>	10 <sup>10</sup> -10 <sup>13</sup>	DIN 53482
Volume resistance	10 <sup>11</sup> -10 <sup>14</sup>	10 <sup>11</sup> -10 <sup>14</sup>	10 <sup>11</sup> -10 <sup>14</sup>	10 <sup>11</sup> -10 <sup>14</sup>	DIN 53482
Moulding shrinkage	1-2 %	1-2 %	1-2 %	1-2 %	

[\* At temperatures over 140°C degradation, not melting, will occur. The exception to this is the heat resistant „secutex Heat“ buffer pad]

---

## BUFFER PAD

---

### Machining

---

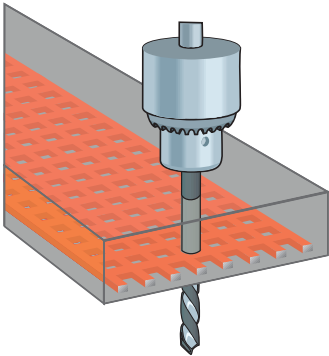

---

#### Drilling

No special tools are required. Normal wood or metal drills are adequate. Cutting speed around 40 m/min; feed rate around 0.01 to 0.03 mm/rev. At low Shore hardnesses, secutex can expand. Therefore, the hole can end up being up to 5% smaller.

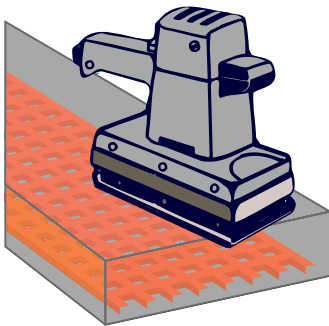

---

#### Grinding and roughening

secutex can be machined using a belt grinder (normal grain or with a ceramic bond). Important! Grinding speed approx. 30 to 50 m/sec.

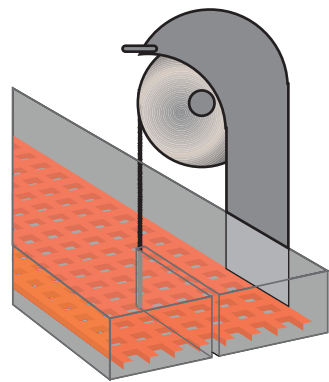

---

#### Cutting and sawing

The secutex material may be sawn using a conventional band saw. The material will attempt to resist the cutting tool. Use as low a wedge angle as possible and, if necessary, adjust the cutting speed.

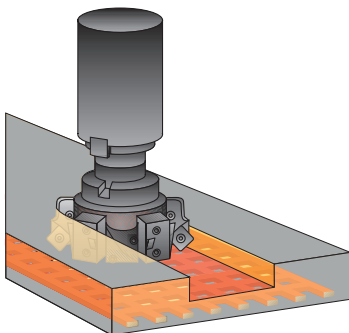

---

#### Milling

Use commercial milling cutters with low numbers of teeth.

---

#### Perforated plate insert Standard 2 mm

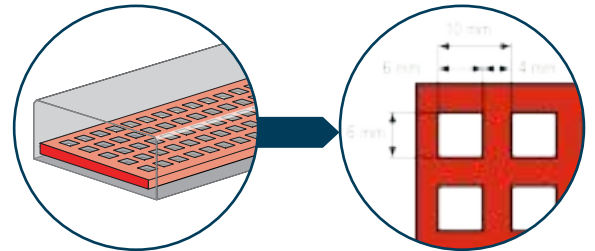

---

#### Perforated plate insert heavy duty version 5 mm

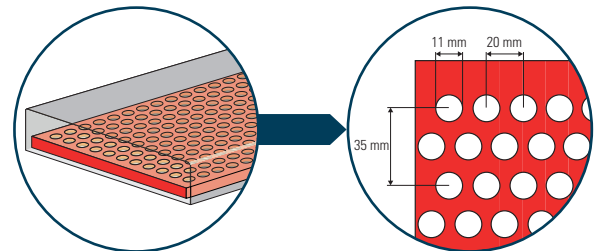

---

#### Stainless steel plate 2 mm

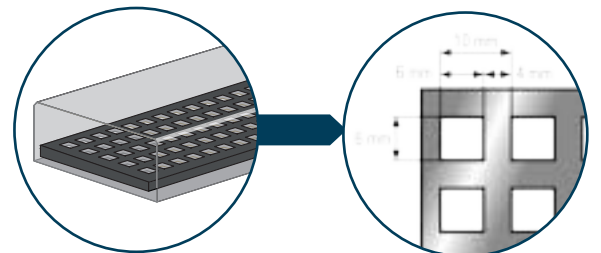

---

secutex-Service: During production, holes, stepped holes and threads are incorporated during casting in accordance with customer specifications and exact measurements. Stamping can also be performed in-house.

---

## BUFFER PAD

SPL-F impact protection for bolting

### Dimensions

Thickness	min. 10 mm
Width	30-1000 mm
Length	Standard-Length 3 m

#### Surface

Smooth  
Polished  
Fabric  
Pyramid

#### PUR options

secutex Transparent 75°  
secutex Yellow 55° | 75° | 90°  
secutex Red „Heat“ 90°

#### Perforated plate options

Perforated plate  
Steel base  
heavy duty version  
stainless steel plate

Our most popular product – secutex impact protection including a perforated plate. Easy and flexible to use and safely secured with the perforated plate serving as reinforcement and providing a universal impact protection in next to no time.

#### Advantages of the perforated plate insert:

- The perforated plate insert prevents longitudinal and lateral extension.
- Simple to secure by bolting and riveting

#### Areas of application:

- Walls, floors, surfaces to be protected, transportation equipment

- Everywhere, where goods are to be protected
- Reduces wear
- Noise reduction, collision protection

#### Examples:

- Collecting troughs
- Grippers
- Sheet metal boxes
- Lifting trucks
- Marina jetties
- Coil hooks
- Stackers
- Corner protection
- Wall and surface protection

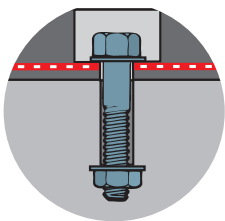
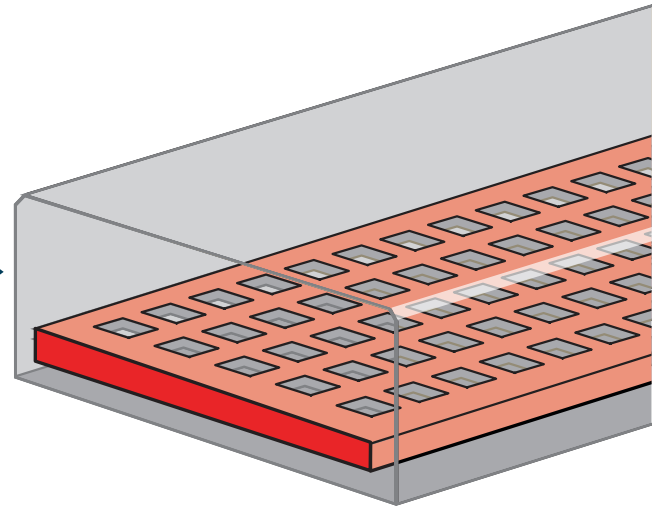

Machine bolt + nut

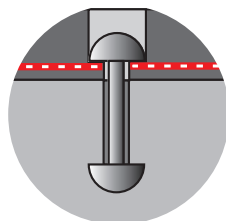

Blind rivet

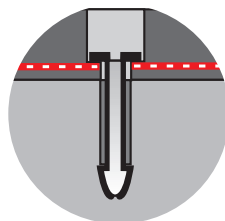

Rivet from front

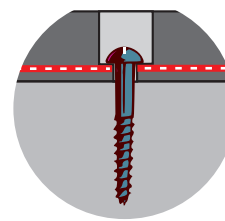

Wood screw from front

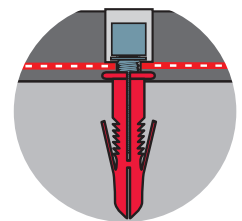

Hexagon socket screw + wall plug



## BUFFER PAD

SPL-F welded impact protection

Conditions are not always the same with regard to impact protection requirements and fixing options. The product must be flexible. secutex provides a solution for all applications. Welding is often the most simple and secure fixing method. The different perforated plate types allow a wide range of applications.

### Advantages

- Simply weld to work piece
- No accurate repeated drilling is required
- No holes in secutex impact protection material
- Completely smooth impact protection surfaces

### Areas of application:

- On all metal surfaces
- On thin metal walls
- Everywhere, where material cannot be bolted or no holes can be drilled

### Examples:

- Collecting troughs
- Sheet metal boxes
- Side railings
- Containers
- Stackers
- Grippers
- Support protection
- Lifting trucks
- Fork protection

### Dimensions

<b>Thickness</b>	min. 10 mm
<b>Width</b>	30-1000 mm
<b>Length</b>	Standard-Length 3 m

<b>Surface</b>	Smooth Polished Fabric Pyramid
<b>PUR options</b>	secutex Transparent 75° secutex Yellow 55°   75°   90° secutex Red „Heat“ 90°
<b>Perforated plate options</b>	Perforated plate Steel base heavy duty version stainless steel plate

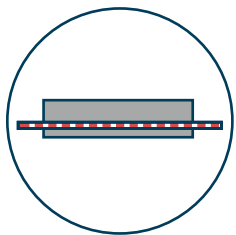
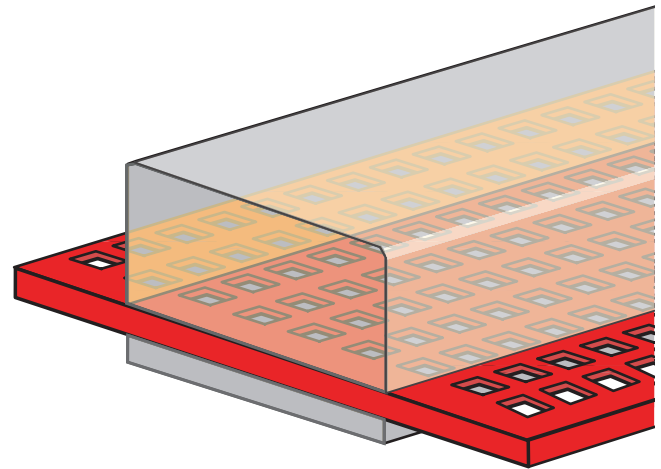

Perforated plate protruding over sides

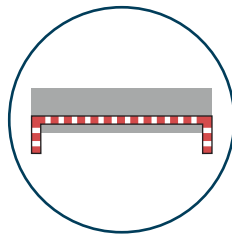

Perforated plate, protruding over sides, angled 90°

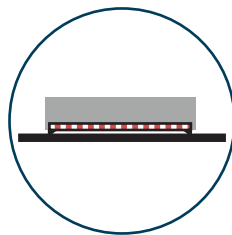
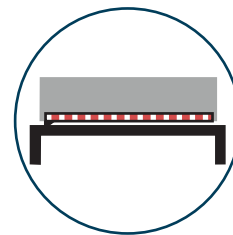
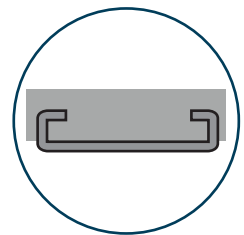

Plate protruding over sides



Plate, protruding over sides, angled 90°



C rail small/large



## BUFFER PAD

SP-F and SPG-F for gluing

### Dimensions

Thickness	min. 10 mm
Width	30-1000 mm
Length (SP-F)	Standard 5 m
Length (SPG-F / SPG-F-F)	Standard 3 m

Where screwing or welding is not possible, simply glue secutex to areas where impact protection is required. No problem for the special secutex adhesive. secutex – the gentle answer to strong impact forces.

### Advantages:

- Can be used (nearly) everywhere as it is glued
- No drilling or welding required
- Glue where welding or screwing is impossible

### Areas of application:

- Thin to medium thick wooden surfaces
- Glass
- Sound-absorbing elements
- Valuable precious wood surfaces

### Examples:

- Refrigerated rooms
- Painted, veneered walls and surfaces
- particularly to meet your requirements

### Surface

Smooth  
Polished  
Fabric  
Pyramid

### PUR options

secutex Transparent  
secutex Yellow  
secutex Red „Heat“

75°  
55° | 75° | 90°  
90°

### Perforated plate options

Without reinforcement (SP-F)  
Reinforced with fabric (SPG-F)  
Reinforced with fibreglass (SPG-F-F)

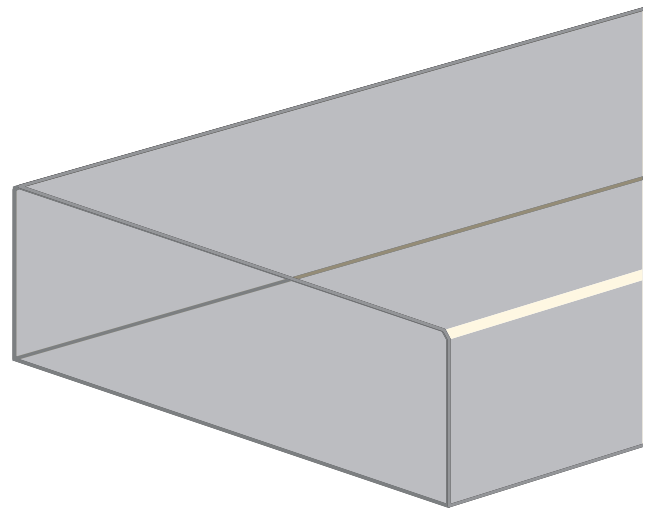

### Special product

secutex with Velcro tape





## BUFFER PAD

SPL-Soft-Powerflex

secutex soft easily absorbs impacts, offering vital surface protection. Sturdy but at the same time impact resistant. Due to its flexible impact-protection layer, secutex soft is particularly suited for sensitive goods and objects with uneven surfaces. secutex soft offers effective impact resistance even under medium loading.

### Advantages:

- Particularly suited for sensitive goods
- Anti-ramming and impact protection layer ideally suited for all applications
- Noise/sound reducing
- Lightweight

### Areas of application:

- Exit/entrance areas and corridors
- Brickwork or concrete manufacturers
- Logistics sector
- Walls of stairwells
- Anti-slip protection during transportation

### Examples:

- Loading areas – rail, lorries, aviation, shipping
- Grippers in brick manufacturing
- Side-impact absorption
- Packaging
- Transportation equipment
- Absorption mats

### Dimensions

<b>Thickness SPL-Soft</b>	min. 15 mm
<b>Thickness SPL-Soft Powerflex</b>	min. 11 mm
<b>Width</b>	30-1000 mm
<b>Length</b>	Standard 3 m

**PUR options**

secutex Transparent Powerflex 75°

**secufoam options**

		<b>Hardness</b>
green	<span style="display: inline-block; width: 20px; height: 10px; background-color: green; border: 1px solid black;"></span>	5   10   15   20
blue	<span style="display: inline-block; width: 20px; height: 10px; background-color: blue; border: 1px solid black;"></span>	5   10   15   20
yellow	<span style="display: inline-block; width: 20px; height: 10px; background-color: yellow; border: 1px solid black;"></span>	10   15   20

**Perforated plate options**

Perforated plate  
Steel base  
heavy duty version  
stainless steel plate

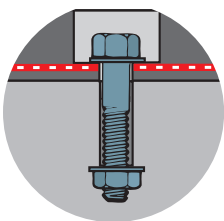
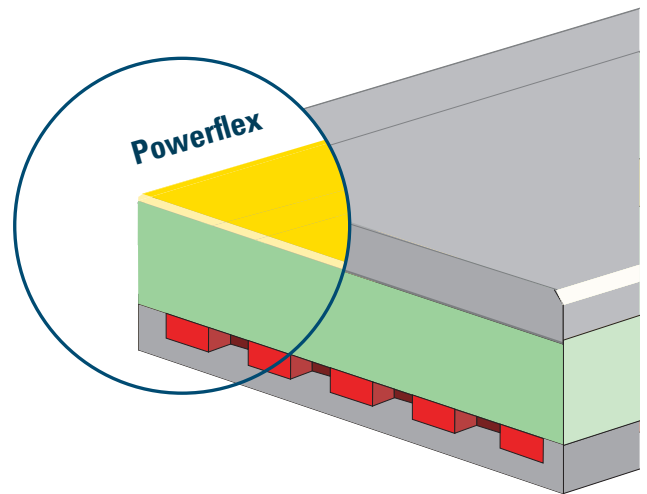

Machine bolt + nut

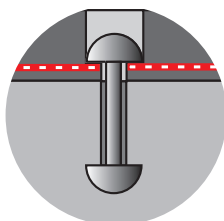

Blind rivet

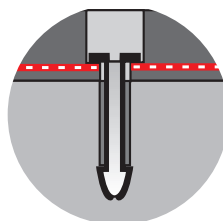

Rivet from front

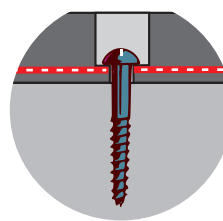

Wood screw from front

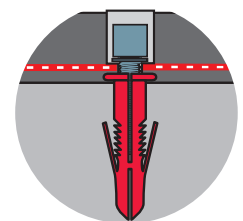

Hexagon socket screw + wall plug



## BUFFER PAD

SPL-HP

### Dimensions

<b>Thickness</b>	min. 40 mm
<b>Width</b>	from 30 mm
<b>Length</b>	Standard 3 m

Sometimes, a hollow design offers the best solution, as the bigger the deformable zone, the higher the impact protection. This does not only apply to cars but everywhere where impact protection is required. Hope for the best – expect the worst. Protect your goods against damage! secutex PROFILE is hollow – but for a very good reason.

#### Advantages:

- Highly flexible
- Precise positioning of cavities ensures large „deformable zones“
- Cushioned impact protection
- Profiles for sliding on to „C“ sections made from metal, concrete or wood

#### Areas of application:

- Edge protection
- Shock protection
- Partial padding
- Impact protection

#### Examples:

- Pipe protection and insulation
- Machine parts
- Boat fenders
- Car parts
- Pipe guides

<b>Surface</b>	Smooth Polished						
<b>PUR options</b>	<table border="0"> <tr> <td>secutex Transparent</td> <td>75°</td> </tr> <tr> <td>secutex Yellow</td> <td>55°   75°   90°</td> </tr> <tr> <td>secutex Red „Heat“</td> <td>90°</td> </tr> </table>	secutex Transparent	75°	secutex Yellow	55°   75°   90°	secutex Red „Heat“	90°
secutex Transparent	75°						
secutex Yellow	55°   75°   90°						
secutex Red „Heat“	90°						
<b>Perforated plate options</b>	<table border="0"> <tr> <td>Perforated plate</td> </tr> <tr> <td>Steel base</td> </tr> <tr> <td>heavy duty version</td> </tr> <tr> <td>stainless steel plate</td> </tr> </table>	Perforated plate	Steel base	heavy duty version	stainless steel plate		
Perforated plate							
Steel base							
heavy duty version							
stainless steel plate							

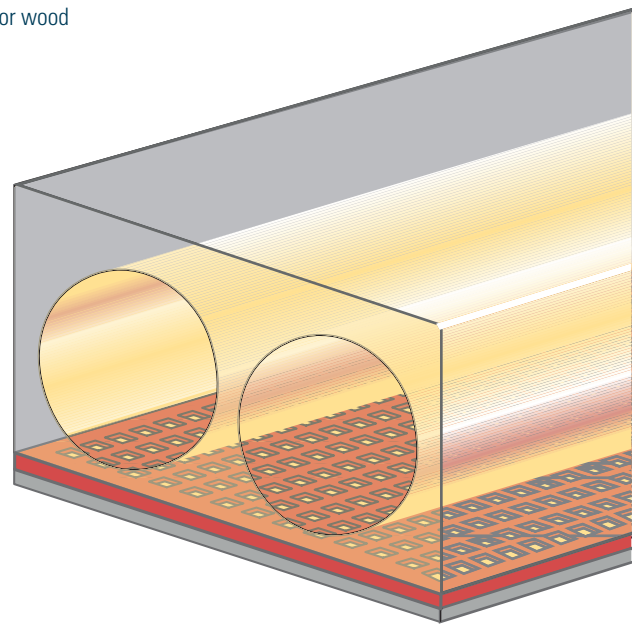

### Options:

Diameter of holes [mm]: 20, 30, 40, 50

Number of holes: 1-5

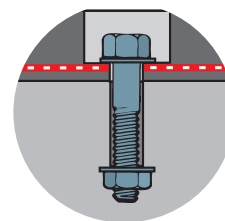
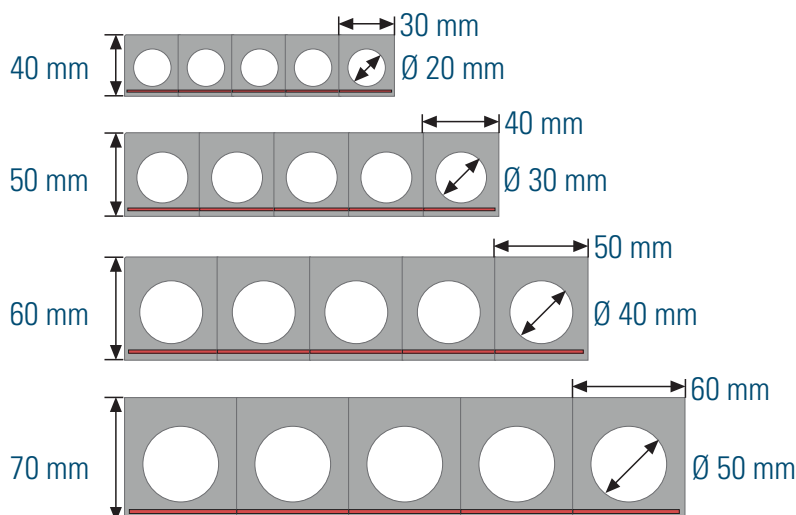

Machine bolt + nut

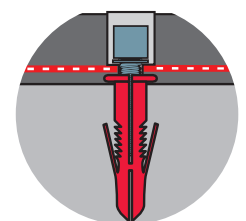

Hexagon socket screw + wall plug

## BUFFER PAD

Angle SPL-W  
Semicircular SPL-HR

### Dimensions

<b>Thickness</b>	10 mm   15 mm   20 mm
<b>Length of legs*</b>	50 mm   75 mm   100 mm
<b>Length</b>	Standard 3 m

\*Other leg length on request

<b>surface</b>	Smooth Polished	
<b>PUR options</b>	secutex Transparent secutex Yellow secutex Red „Heat“	75° 55°   75°   90° 90°
<b>Perforated plate options</b>	Perforated plate Steel base heavy duty version stainless steel plate	

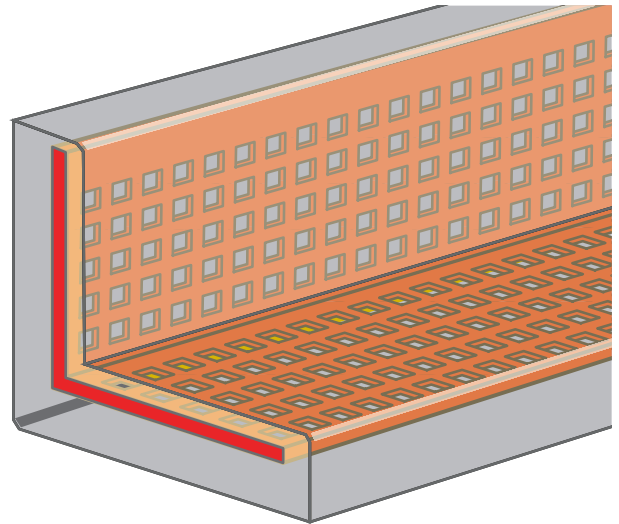

### Dimensions

<b>Diameter</b>	30 mm - 120 mm
<b>Length</b>	Standard 3 m

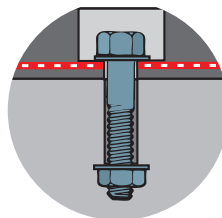

Machine bolt + nut

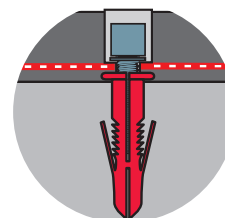

Hexagon socket screw + wall plug

<b>Surface</b>	Smooth Polished	
<b>PUR Varianten</b>	secutex Transparent secutex Yellow secutex Red „Heat“	75° 55°   75°   90° 90°
<b>Perforated plate options</b>	Perforated plate Steel base heavy duty version stainless steel plate	

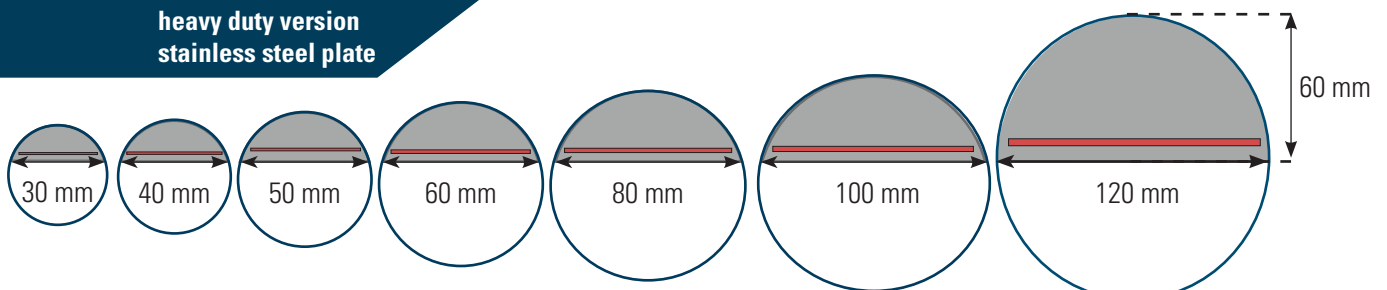
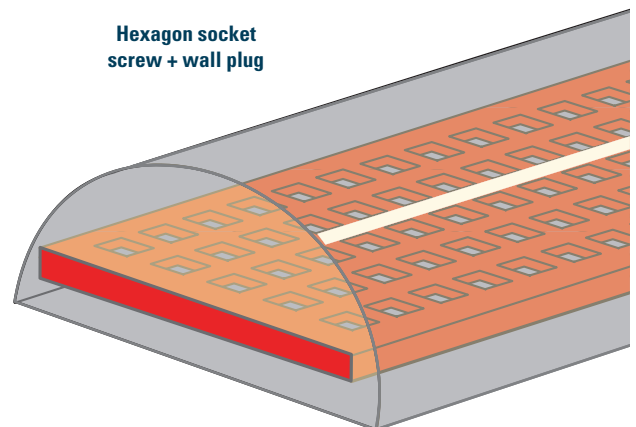

---

**FORK PROTECTION**

---

secutex fork protection shoes

---

---

secutex fork protection shoes  
protect your loads





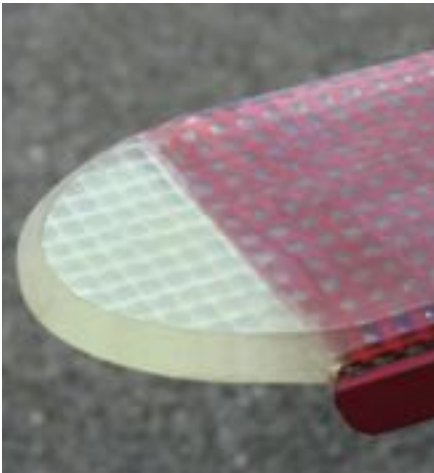

### SZ-S1

Standard design with flexible tip

The standard configuration is designed for flexible use. It offers simple and quick manipulation and is designed to be suitable for most applications. Specially developed „Flexotip“ protects load and fork protection.

secutex fork protection shoes are also available in stainless steel; e.g. for the food industry.

Type	Internal width [mm]	External width [mm]	Coating [mm]
<b>SZ-S1</b>	+ 5 - 8	+15-20	12

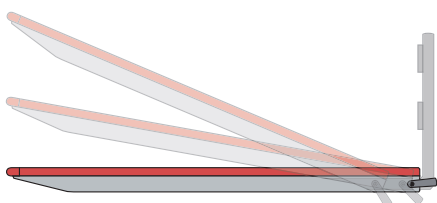
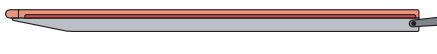

**Please note:**  
Fork protection shoes have no carrying function.

### SZ-SSL

Heavy duty design with steel tip

The SZ-SSL is a specially designed fork protection shoe for heavy duty use.

The sturdy steel construction with steel tip is especially constructed for hard continuous use.

Type	Internal width [mm]	External width [mm]	Coating [mm]
<b>SZ-SSL</b>	+5 - 8	+15-20	15

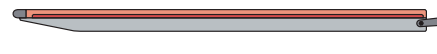

### SZ-HR

Fork protection shoe (semicircular design)

This prong protection shoe has a semi-circular impact protection surface. This way, round loads like concrete pipes and wire spools can be transported safely and gently. The angled prongs facilitate the loading.

Type	Internal width [mm]	External width [mm]
<b>SZ-HR</b>	+5 - 8	+15-20

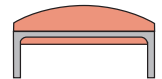

#### Surface structures

For special applications that will be affected by water, oil or ice, we offer special surfaces. Talk to your expert adviser!

## FORK PROTECTION

secutex fork protection - fixed coating

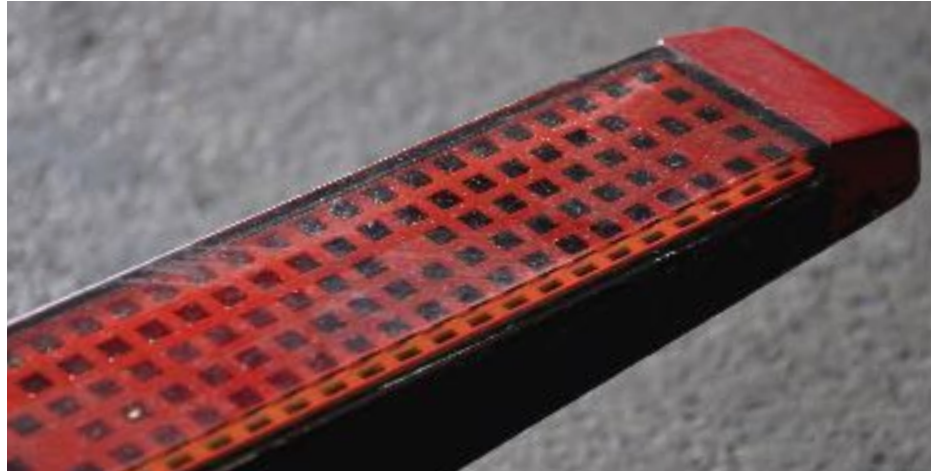

### Fork protection for continuous heavy duty use

#### SZ-F1

Forks with fixed coating

The configuration offers maximum protection for load and lifting gear and requires little space. secutex fixed coating is inseparably bonded to the fork prongs; the perforated plate prevents it from detaching from the fork prongs. A crossbar at the tip of the fork prong prevents the secutex coating from peeling off.

Type	Internal width [mm]	External width [mm]	Coating [mm]
SZ-F1	---	fork width	10 - 12

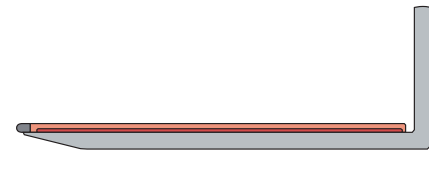

#### SZ-F2

Shanks with fixed coating

This configuration offers maximum protection for goods that, for example, overhang the pallet edge. The secutex coating is inseparably bonded to the fork shanks. The perforated plate prevents separation from the fork shank.

Type	Internal width [mm]	External width [mm]	Coating [mm]
SZ-F2	---	fork width	10 - 12



#### Surface structures

For special applications that will be affected by water, oil or ice, we offer special surfaces. Talk to your expert adviser!

## FORK PROTECTION

### Fork protection - fork extension



#### SZ-GVO

Standard design; open at bottom

The SZ-GVO is an ideal extension that is very light. As with all fork protection products, the SZGVO can be fitted with secutex buffer pad.

The thickness and width of the fork extension are based on prong width, prong thickness and carrying capacity.

Type	External width [mm]	Coating [mm]
<b>SZ-GVO</b>	ca. + 30	10 - 12

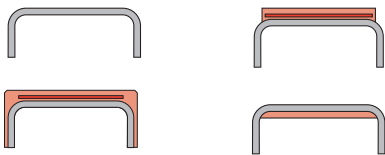

#### SZ-GVG

Closed design

Fork extensions are the ideal solution where loads need to be transported that are longer than the fork prongs.

Type	External width [mm]	Coating [mm]
<b>SZ-GVG</b>	ca. + 30	10 - 12



### Extend your forks

Please note: The extension must be supported by at least 60% of the existing fork prong. The carrying capacity of the fork extension is dependent on the particular fork. Please pay attention to the carrying capacity and centre of gravity of the forklift truck.

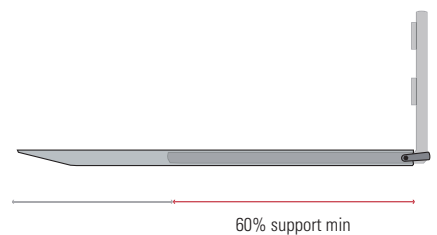

#### Surface structures

For special applications that will be affected by water, oil or ice, we offer special surfaces. Talk to your expert adviser!

---

## **FORK PROTECTION**

---

secutex fork protection for fork shanks

---

---

secutex fork protection for  
fork shanks







### SZ-S2

For careful transport

secutex fork shank protection is used for careful transport of loads. The purpose is to prevent damage to the load during transport.

The fork shank protection is attached to the fork shanks via steel bands and is thus easily exchangeable.

Typ	Internal width [mm]	External width [mm]	Coating [mm]
<b>SZ-S2</b>	+5 - 8	+15 - 20	12

### SZ-S2 hollow profile

Sturdy with high damping activity

secutex fork shank protection with hollow profiles is robustly designed for the protection of the transported goods. The hollow cavities have a high damping effect during impact with the load. Areas of application include, for example, the transport of bricks in the brick industry or concrete pipes in the cement industry.

The fork shank protection is attached to the fork shanks via steel bands and is thus easily exchangeable.

Typ	Internal width [mm]	External width [mm]	Coating [mm]
<b>SZ-S2 HP</b>	+5 - 8	+15 - 20	30

### SZ-S2 Soft

For delicate goods

secutex fork shank protection with foam insert is designed for the careful transport of delicate goods. After impact the foam compresses, however reforms its shape once the load is lifted. Areas of application include, for example, the transport of delicate plasterboards and roof tiles etc.

The fork shank protection is attached to the fork shanks via steel bands and is thus easily exchangeable.

Typ	Internal width [mm]	External width [mm]	Coating [mm]
<b>SZ-S2 Soft</b>	+5 - 8	+15 - 20	15-30

---

## FORK PROTECTION

---

secutex fork protection - fixed coating  
coil Fork protection - pipe module

---

---

Fork protection for continuous  
heavy duty use

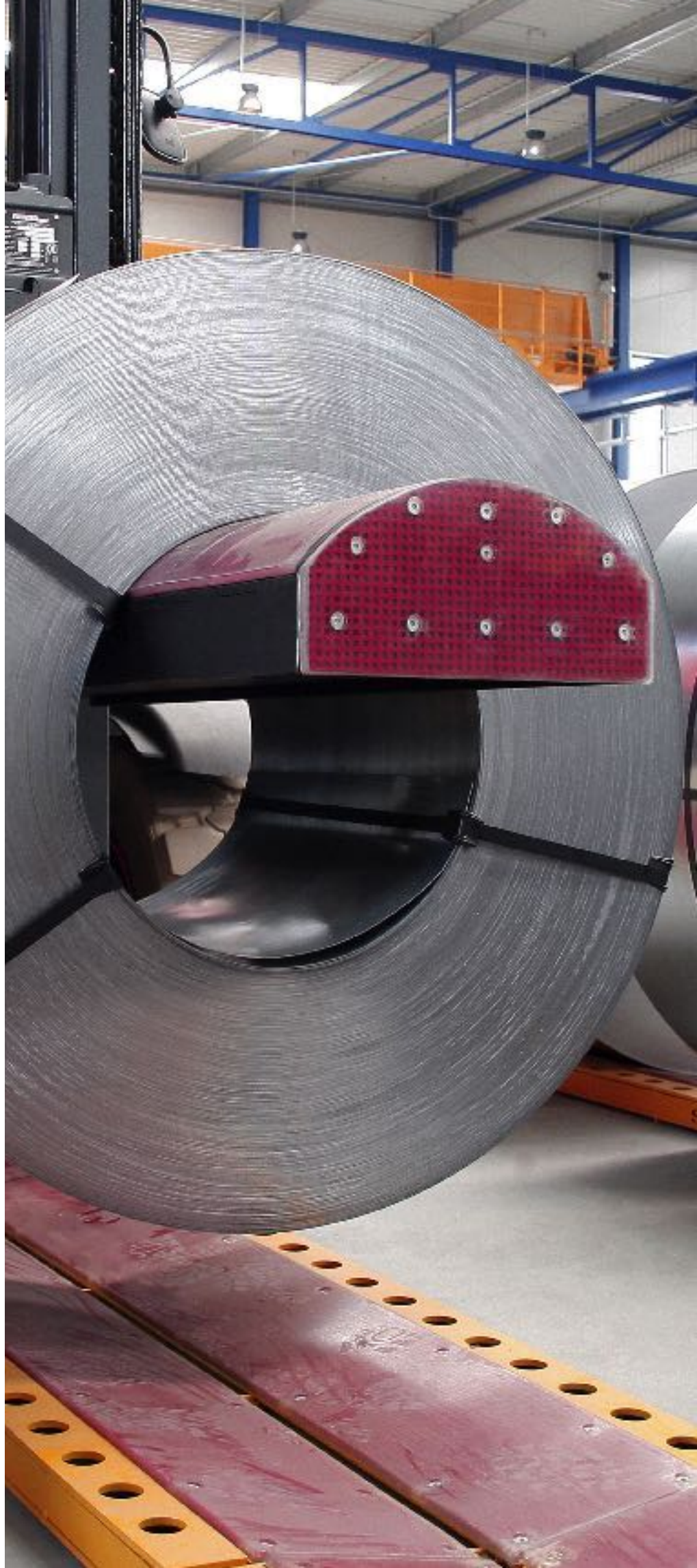



## SZ-F1

### Forks with fixed coating

The configuration offers maximum protection for load and lifting gear and requires little space. secutex fixed coating is inseparably bonded to the fork prongs; the perforated plate prevents it from detaching from the fork prongs. A crossbar at the tip of the fork prong prevents the secutex coating from peeling off.

Typ	Internal width [mm]	External width [mm]	Coating [mm]
SZ-F1	---	Fork width	10 - 12



## SZ-C

### Coil fork protection with/without drive-in chamfer

Transport metal coils and wire rings safely and reliably using the secutex coil shoe.

The radius of the bearing surface is matched exactly to the internal diameter of the coil. Thus damage to material is reliably prevented. The coil sits securely thanks to the high friction of the secutex coating. It is almost impossible for the coil to slip off. The drive-in chamfer enables simple driving into the coil.

The coil fork protection is available with and without drive-in chamfer.

Typ	Internal coil $\varnothing$ [mm]
SZ-C	400/500/600

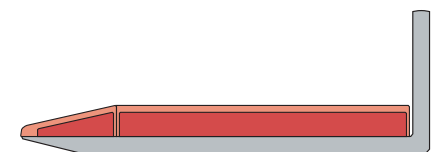

## SZ-RM

### Pipe module fork protection

The pipe module fork protection provides maximum protection for fragile, round loads. It is extremely wear-resistant, very slip-resistant and easily replaceable.

The pipe module fork protection is simply pushed onto the existing mandrel and fastened with the end cap. The individual modules are free-rotating and simply turn away if subjected to unfavourable stress.

Typ	Module length [mm]	Wall thickness [mm]	End plate length [mm]
SZ-RM	250	15 - 20	90

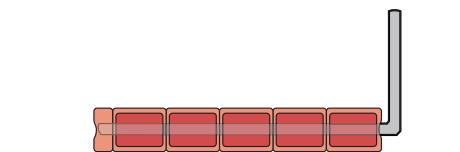

### Surface structures

For special applications that will be affected by water, oil or ice, we offer special surfaces. Talk to your expert adviser!



---

## COLLISION PROTECTION

---

Collision protection for shelving supports  
Collision protection for corners and posts

---

---

Avoid repairs by using  
secutex collision protection











### Collision protection for shelving supports

Even slight dents can adversely affect the stability of a high-bay warehouse. The collision protection for shelf supports protects against damage caused by frontal impact. The hollow cavities in the buffer pad profile dampen the collision energy, the solid steel profile on the inside prevents bending of the shelving supports.

### Crash guards for corners and posts

The crash guard is bolted to the floor and serves as collision protection, for example, on shelves, high-speed doors, etc. The surrounding buffer pad band absorbs the impact energy of the forklift or pallet truck. This provides higher service lives in comparison to conventional steel angle bars.

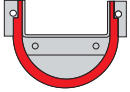
Typ	Height [mm]	Plan view
SAS-AB	1.000	
SAS-B	1.000	

Typ	Height [mm]	Plan view
SAS-E	400	
SAS-D	400	
SAS-C	400	

---

## SECUTEX-SOLUTIONS

---

Special products  
secuGrip 90

---

---

Extreme wear-resistance,  
high friction coefficient



---

### Hook coating

The thin coating provides an anti-slip protection of the load when used in both wet and dry areas. At the same time, the surface protects against damage and scratches to delicate surfaces.

---

Typ	Coating [mm]
secugrip 90	2

---

---

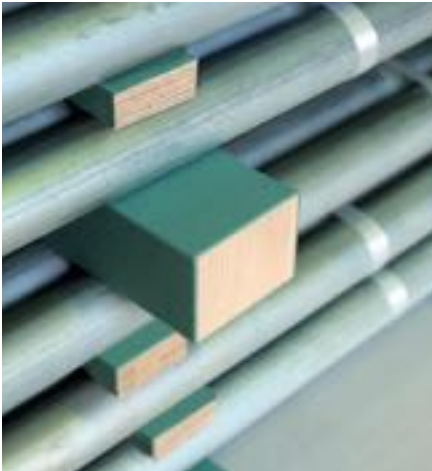

## Bar coating

The thin coating has a high friction coefficient and therefore an anti-slip protection. The permanent coating is an alternative to conventionally used anti-slip mats. The secugrip coating is inseparable from the wood.



## Fork coating

The design provides protection for the load and lifting device at very low retraction heights. The fixed coating is inseparable from the fork prongs. A crossbeam at the tip of the fork prong prevents the secutex coating from peeling.



## HGV usable area coating

The secugrip 90 coating can be used to coat wood, metal or even adhesive film. This allows the customer to line individual surfaces and therefore prevents loads from slipping.

Typ	Coating [mm]
secugrip 90	1-2

Typ	Coating [mm]
secugrip 90	3

Typ	Coating [mm]
secugrip 90	2

**Prüfzeugnis über Reibbeiwerte**  
Geprüft nach VDI 2700 Blatt 14



für Firma.: SpanSet-secutex GmbH

**1 Beschreibung der Reibpartner**

1.1 Auflagefläche:  
1.1.1 Art : MULTIPLEX Platten mit secugrip-90 Beschichtung  
1.1.2 Typ : secugrip-90  
1.1.3 Zustand : neu

1.2 Ladegut:  
1.2.1 Art : Europool-Gitterbox (EPAL)  
1.2.2 Abmessungen [cm] : 80 x 120  
1.2.3 Masse des Ladeguts [kg] : 1109  
1.2.4 Kontaktfläche (bei Verwendung von RHM) [cm<sup>2</sup>] : ---

**2 Prüfbedingungen**

2.1 Umgebungstemperatur: 23 [°C]  
2.2 Ort und Datum der Prüfung : DEKRA Automobil Test Center Klettwitz, 24.08 - 12.09.2016

  
Abbildung 1

  
Abbildung 2

**3 Ermittelte Gleit-Reibbeiwerte**

Anordnung Auflagefläche	Anordnung Ladegut	siehe Foto	Ergebnis $\mu$
längs	längs	Abbildung 1	0,69
quer	quer	Abbildung 2	0,65

Dipl.-Ing. (FH) Ulf Bulling  
Fachspezialist

Klettwitz, 20.09.2016  
Ort, Datum der Ausstellung

Alle Einzelergebnisse wurden im Bericht Nr. 201639366-1 dokumentiert.  
- DEKRA Automobil GmbH, Automobil Test Center -  
Senftenberger Straße 30, D-01998 Klettwitz; Telefon (035754) 7344-500, Fax (035754) 7345-500, E-Mail [gen@dekra.com](mailto:gen@dekra.com)

**Prüfzeugnis über Reibbeiwerte**  
Geprüft nach VDI 2700 Blatt 14



für Firma.: SpanSet-secutex GmbH

**1 Beschreibung der Reibpartner**

1.1 Auflagefläche:  
1.1.1 Art : MULTIPLEX Platten mit secugrip-90 Beschichtung  
1.1.2 Typ : secugrip-90  
1.1.3 Zustand : neu

1.2 Ladegut:  
1.2.1 Art : Europool-Palette  
1.2.2 Abmessungen [cm] : 80 x 120  
1.2.3 Masse des Ladeguts [kg] : 1026  
1.2.4 Kontaktfläche (bei Verwendung von RHM) [cm<sup>2</sup>] : ---

**2 Prüfbedingungen**

2.1 Umgebungstemperatur: 23 [°C]  
2.2 Ort und Datum der Prüfung : DEKRA Automobil Test Center Klettwitz, 24.08 - 12.09.2016

  
Abbildung 1

  
Abbildung 2

**3 Ermittelte Gleit-Reibbeiwerte**

Anordnung Auflagefläche	Anordnung Ladegut	siehe Foto	Ergebnis $\mu$
längs	längs	Abbildung 1	0,74
quer	quer	Abbildung 2	0,74

Dipl.-Ing. (FH) Ulf Bulling  
Fachspezialist

Klettwitz, 20.09.2016  
Ort, Datum der Ausstellung

Alle Einzelergebnisse wurden im Bericht Nr. 201639366-1 dokumentiert.  
- DEKRA Automobil GmbH, Automobil Test Center -  
Senftenberger Straße 30, D-01998 Klettwitz; Telefon (035754) 7344-500, Fax (035754) 7345-500, E-Mail [gen@dekra.com](mailto:gen@dekra.com)

## Friction coefficient (DEKRA)

secuGrip 90 for Europool pallets 0.74  $\mu$

secuGrip 90 for Europool pallet cage 0.65  $\mu$

You can find the data for download at:  
[http://www.secutex.com/wp-content/uploads/2016/03/DEKRA-Prüfzeugnis\\_secugrip90.pdf](http://www.secutex.com/wp-content/uploads/2016/03/DEKRA-Prüfzeugnis_secugrip90.pdf)

## SECUTEX-SOLUTIONS

Special products  
secuGrip 75

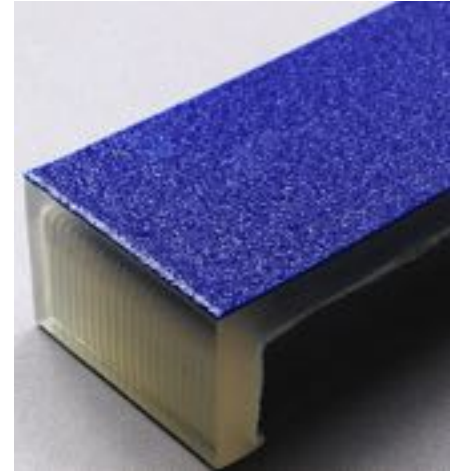

Extreme wear-resistance,  
high friction coefficient

### Bar coating

The thin coating has a high friction coefficient and therefore an anti-slip protection. The permanent coating is an alternative to conventionally used anti-slip mats. The secugrip coating is inseparable from the wood.

### secuGrip 75 auf Polyurethan

Die Dünnschichtung kann auf Wunsch auch auf Polyurethan beschichtet werden. Dabei dient das Polyurethan auf der Unterseite zur Lärmreduzierung und die secuGrip-Beschichtung auf der Oberseite zur Erhöhung des Reibwertes. Die secuGrip-Beschichtung wird untrennbar mit dem Polyurethan verbunden.

Type	Coating [mm]
secuGrip 75	1-2

Type	Coating [mm]
secuGrip 75	2-3

### Friction coefficients (DEKRA)

#### Condition: surface dry

secuGrip 75 to Europool range 0,91  $\mu$

secuGrip 75 zu Europool grid box 0,73  $\mu$

### Friction coefficients (DEKRA)

#### Condition: surface wet

secuGrip 75 zu Europool range 0,6  $\mu$

secuGrip 75 to Europool grid box 0,4  $\mu$  - 0,5  $\mu$

Prüfzeugnis über Reibbelwerte  
Geprüft nach VDI 2700 Blatt 14

DEKRA

für Firma.: SpanSet-secutex GmbH

**1 Beschreibung der Reibpartner**

1.1 Auflagefläche  
1.1.1 Art : MULTIPLEX Platten mit secuGrip-75 Beschichtung  
1.1.2 Typ : secuGrip-75  
1.1.3 Zustand : neu, trocken

1.2 Ladegut:  
1.2.1 Art : Europool-Palette  
1.2.2 Abmessungen [cm] : 80 x 120  
1.2.3 Masse des Ladeguts [kg] : 1030  
1.2.4 Kontaktfläche (bei Verwendung von RHM) [cm<sup>2</sup>] : ---

**2 Prüfbedingungen**

2.1 Umgebungstemperatur : 23 [°C]  
2.2 Ort und Datum der Prüfung : DEKRA Automobil Test Center Klettwitz, 12.10. - 17.10.2017

**3 Ermittelte Gleitreibbelwerte**

Anordnung Auflagefläche	Anordnung Ladegut	siehe Foto	Ergebnis $\mu$
längs	längs	Abbildung 1	0,91
quer	quer	Abbildung 2	0,85

Dipl.-Ing. (FH) Ulf Bulling  
Fachspezialist

Klettwitz, 21.11.2017

Der berechnete Gleitreibwert nach DIN EN 12195-1:2011-06 beträgt unter Verwendung des Umrechnungsfaktors 0,925 in Längsrichtung  $\mu = 0,98$  und in Querrichtung  $\mu = 0,92$ .

Alle Einzelergebnisse wurden im Bericht Nr. 201742704-1 dokumentiert.

DEKRA Automobil GmbH, Automobil Test Center  
Senftenberger Straße 30, D-01998 Klettwitz, Telefon (035754) 7344-500, Fax (035754) 7345-500, E-Mail [info@dekra.com](mailto:info@dekra.com)

Prüfzeugnis über Reibbelwerte  
Geprüft nach VDI 2700 Blatt 14

DEKRA

für Firma.: SpanSet-secutex GmbH

**1 Beschreibung der Reibpartner**

1.1 Auflagefläche:  
1.1.1 Art : MULTIPLEX Platten mit secuGrip-75 Beschichtung  
1.1.2 Typ : secuGrip-75  
1.1.3 Zustand : neu, trocken

1.2 Ladegut  
1.2.1 Art : Europool-Gitterbox (EPAL)  
1.2.2 Abmessungen [cm] : 80 x 120  
1.2.3 Masse des Ladeguts [kg] : 1115  
1.2.4 Kontaktfläche (bei Verwendung von RHM) [cm<sup>2</sup>] : ---

**2 Prüfbedingungen**

2.1 Umgebungstemperatur : 23 [°C]  
2.2 Ort und Datum der Prüfung : DEKRA Automobil Test Center Klettwitz, 12.10. - 17.10.2017

**3 Ermittelte Gleitreibbelwerte**

Anordnung Auflagefläche	Anordnung Ladegut	siehe Foto	Ergebnis $\mu$
längs	längs	Abbildung 1	0,73
quer	quer	Abbildung 2	0,68

Dipl.-Ing. (FH) Ulf Bulling  
Fachspezialist

Klettwitz, 21.11.2017

Der berechnete Gleitreibwert nach DIN EN 12195-1:2011-06 beträgt unter Verwendung des Umrechnungsfaktors 0,925 in Längsrichtung  $\mu = 0,79$  und in Querrichtung  $\mu = 0,74$ .

Alle Einzelergebnisse wurden im Bericht Nr. 201742704-1 dokumentiert.

DEKRA Automobil GmbH, Automobil Test Center -  
Senftenberger Straße 30, D-01998 Klettwitz, Telefon (035754) 7344-500, Fax (035754) 7345-500, E-Mail [info@dekra.com](mailto:info@dekra.com)





---

## Coating for pipe raising systems

The noise levels in pipe and rod raising systems can be very high. A chute lined with secutex pipe modules ensures that noise levels are reduced and that surfaces are protected.

The secutex material with inset perforated plates is particularly wear-resistant and cushions the movement of pipes and rods very well.

The cast sections are attached using drilled attachment holes. Segment sizes and joins are manufactured according to client requests.



---

## secutex-wiper

### Wipers for steel bars

In the production of pipes and steel bars, so-called wipers are used for cleaning. The wipers have a round or rectangular outer profile and an inner profile that matches the shape of the object to be cleaned. Normally, several wipers are mounted in series, whereby the pass-through openings are smaller than the profile. The bar is pushed through the elastomer plates at high velocity, and the rubbery material strips the surface free from grease and cleaning fluid residues.

### It is the edge that counts!

Just like a car window wiper, it is the edge that counts. Normally, the wipers are stamped from sheet goods. During stamping, the elastomer becomes distorted; the inner edge is therefore not dimensionally stable and is at an angle. Only part of the edge wipes emulsions from the surfaces depends on the profiles. This edge is rapidly worn down; the cleaning action is then unsatisfactory.

### Streak-free cleaning

In collaboration with a renowned pipe manufacturer, secutex has developed a new wiper whose optimised wiper edge cleans a rough surface without leaving streaks. The secutex wipers are cast from moulds; the stamping process is done away with. The edge is perfectly formed and lies in complete contact with the pipes and steel bars passing through it.

### Long service life

Users report the excellent durability of the secutex wipers; premature wear and material decomposition have not been observed. Thanks to the excellent service life, set-up times and downtimes could be significantly reduced.

### For every size

secutex wipers can be produced in all required thicknesses and diameters.



---

## secutex-funnel

### Funnels for pipes and bright steel

In the production of pipes and bright steel so-called funnels are used for threading in the production plants. In most cases funnels made of polyamide are used, but due to the material hardness and the sharp-edged pipe ends wear out very quickly.

### It depends on the material sphere

As an alternative, secutex offers polyurethane funnels for this purpose. In contrast to polyamide, these are softer from the material and therefore also more wear-resistant than sharp-edged pipe ends. This means longer service life for the customer as well as better surface protection for very sensitive materials.

### For every size

secutex funnels can be produced in the required dimensions according to customer drawings.

## COILPROTECT

secutex-Coilprotect  
secutex-Coilmats



For careful coil handling and safe storage

### secutex wire coil mat

Mat with cross grooves

The proven secutex wire coil mat reliably prevents scratches and dents. The lightweight mat can be positioned quickly. Users especially rate the new roll-off stop. The individual wire rings hook firmly into the transverse grooves, the wire bundles no longer slip and an additional bundling is no longer necessary.

#### Available as an option

- Oil drainage channel
- Surface made from heat-resistant secutex heat buffer pad (up to 150°C)
- Mounting holes
- Sloping head and tail pieces for forklift access.

Height [mm]	Width [mm]	Length [mm]	Coil-ø [mm]
43	400	3.000*	bis 1600
54	400	3.000*	bis 1800

\*Up to a length of 5,000 mm upon request

### secutex coil mat

Flexible mat made of secutex buffer pad

The light and mobile coil mat was designed for the storage of coils. It is convenient to use. Thus makeshift storage can be set up rapidly and flexibly or existing storage can be expanded in the event of bottlenecks.

#### Available as an option

- Carrying handle and oil drainage channel
- Surface made from heat-resistant secutex heat buffer pad (up to 140 °C)
- Mounting holes
- Sloping head and tail pieces for forklift access.

Height [mm]	Width [mm]	Length [mm]	Coil-ø [mm]
30	400	3.000*	800 - 1.400
43	400	3.000*	1.000-1.600
54	400	3.000*	1.200-1.800
65	500	3.000*	1.200-2.100



Connecting element for coil mats



## Coilprotect Altus

### High-profile coil rack

High-profile secutec coil cradle for long-term storage of coils of various sizes. This coil rack can only be loaded with a coil hook or coil tongs.

#### Available as an option

- Buffer pad made from heat-resistant secutec heat buffer pad
- Coated supporting rods
- Trolley for supporting rods
- End frame for diagonal and vertical storage

1	Height [mm]	Width [mm]	Length [mm]	Coil-ø [mm]
	206	1.225	1.000	1.200-2.400
	206	1.225	1.500	1.200-2.400
	206	1.225	2.000	1.200-2.400
	206	1.225	2.500	1.200-2.400
	206	1.225	3.000	1.200-2.400

Grid of the marker poles middle/middle: 125 mm



## Coilprotect Semi

### Low-profile coil rack

Low-profile secutec coil cradle for long-term storage of coils of all sizes. The coil cradle may be loaded using coil hook/coil tongs as well as with a forklift truck.

#### Available as an option

- Buffer pad made from heat-resistant secutec heat buffer pad
- Coated supporting rods
- Trolley for supporting rods
- End frame for diagonal and vertical storage

2	Height [mm]	Width [mm]	Length [mm]	Coil-ø [mm]
	80	675	1.000	800-2.000
	80	675	1.500	800-2.000
	80	675	2.000	800-2.000
	80	675	2.500	800-2.000
	80	675	3.000	800-2.000

Grid of the marker poles middle/middle: 100 mm



## Coilprotect „Premium“

### Coil storage with low design

The Coilprotect Premium is a further development to the already existing Coilprotect Semi. The second set of stake enables an even closer stake out, especially for narrow slit strips.

The coil tray can be equipped with a coil hook and coil tongs. A fork lift assembly must be checked by the customer due to the greater width of the coil tray.

#### Optional

- buffer pad made of heat resistant bufferpad „secutec Heat“
- Coated supporting rods
- Trolley for supporting rods
- End frame for diagonal and vertical storage

	Height [mm]	Width [mm]	Length [mm]	Coil-ø [mm]
	80	833	1.000	800-2.000
	80	833	1.500	800-2.000
	80	833	2.000	800-2.000
	80	833	2.500	800-2.000
	80	833	3.000	800-2.000

Grid of the marker poles middle/middle: 50 mm



---

**SPECIAL PRODUCTS**

---

Coil-Handling

---

---

For careful coil handling



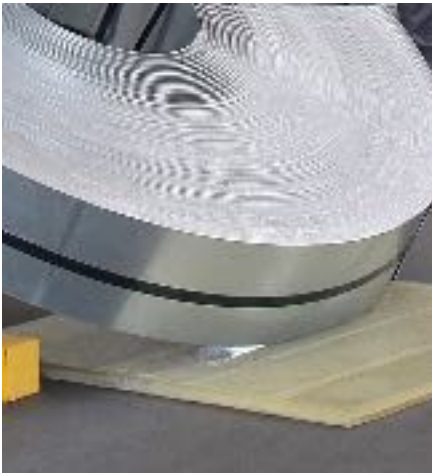

## secutex turning mat

### Careful and controlled turning

When rolling off a load over the floor, the heavy load can slip uncontrollably on the smooth warehouse floor. There is considerable risk of accidents. Expensive workpieces can be damaged under their own weight and may require time-consuming reprocessing. secutex turning mats (see figure above) are completely slip-resistant. The turning manoeuvre can be performed safely and smoothly.

Thickness [mm]	Width max. [mm]	Length max. [mm]
20	1.000	3.000
30	1.000	3.000
50	1.000	3.000



## Slit strip lifting sling

### The problem

The erection of stacked coils on the stack is not permitted! Therefore, the first choice for erecting split coil packages delivered lying flat is a coil turner. However, a fixed facility for turning narrow coils is not always available. Therefore, we offer a solution that may be brought into operation, after prior and thorough training of the slinger.

### The solution

An end loop of secutex lifting slings for slit strips is flat and can easily be pushed into the gap between the slit strips. The flat end loop is then simply hung over the forged coil hook. The protective tubing is positioned at the sharp edges of the coil. During lifting the lifting sling moves freely within the protective tubing, while the latter remains fixed against the load. Therefore, there is no movement and at the sharp edges and hardly any wear.

The turning of stacked coils on the stack is liable to cause accidents, since the slit strip can slip over the bottom edge during erection. Therefore, as part of the kit you will always receive a slip-resistant secutex turning mat (above) which is simply placed under the tipping edge. A positive side-effect: the windings of the underlying coil are not damaged during the turning procedure.

Thickness [mm]	Width [mm]	Length [mm]
10	200	300



## Coiler mandrel sheath

Again and again, coils with a larger internal diameter than expected have to be processed on coilers. Here the secutex coiler sheath offers a simple and flexible solution to the problem.

### Enlargement of the internal diameter

The handy secutex coiler sheath is simply pushed onto the coil mandrel and enlarges the radius to the required size. The time-consuming assembly of subcomponents is no longer necessary.

### Prevention of dents

Thanks to the high friction of the secutex material, the coil cannot slip and, in some cases, the contact pressure can be significantly reduced. The typical impressions in the initial winding layers are prevented and material wastage is significantly reduced.

The secutex material is extremely wear-resistant and, unlike standard rubber, it is also oil-resistant. The insertion tip helps thread the coils.

Internal Ø [mm]	External Ø [mm]	Coil internal Ø [mm]	Length max. [mm]
390	490	508	2.000
490	590	608	2.000



---

## SECUROLL

---

Technical specifications rollers  
with replaceable core

---

---

The special coating for  
rollers and cylinders

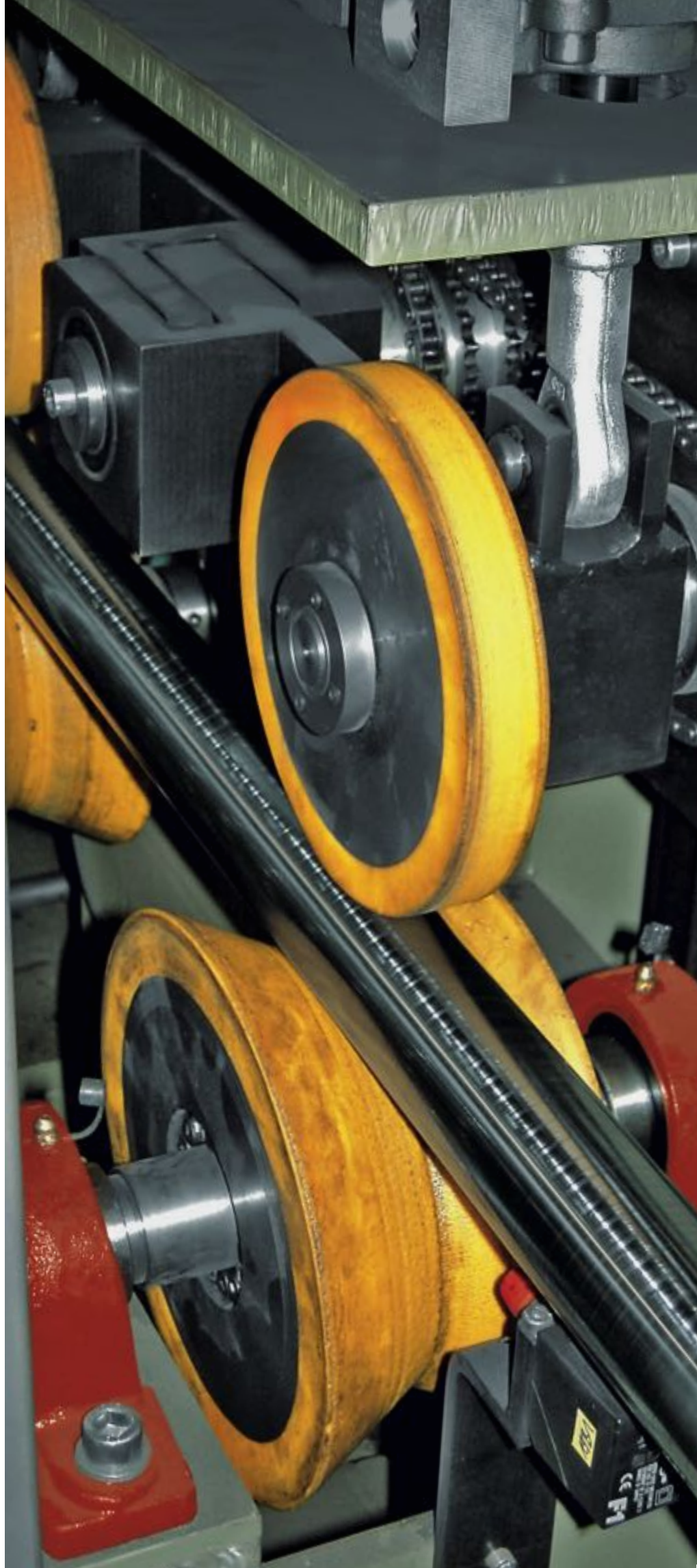



### secutex- securoll

With securoll secutex offers a specially developed coating for cylinders and rolls, which is cast in form or applied directly onto the roller core. During product development the vast experience of secutex with all types of coatings was introduced.

secutex supplies a wide selection of securoll for almost any application. Material hardnesses of 55°-90° Shore are supplied. The innovative process ensures high precision in the coating with very low tolerances as well as optimum and long-term bonding between the cylinder/roller core and the securoll material. This ensures that the securoll-coated cylinders and rollers have a high degree of mechanical strength and wear resistance.

#### Available as an option

- SP-sleeve for hosting



### secutex rollers with exchangeable core

The securoll rolls have an easily-assembled, exchangeable steel core consisting of two side plates and the required central axis.

The exchangeable cores are cast separately from the extremely wear-resistant and tear-resistant secutex material. The two side plates and the central axis are put together with the secutex exchangeable core and bolted together.

We can provide any size and any shape without any problems. In the unique mould produced, required secutex replacement cores can also be produced within a very short time.

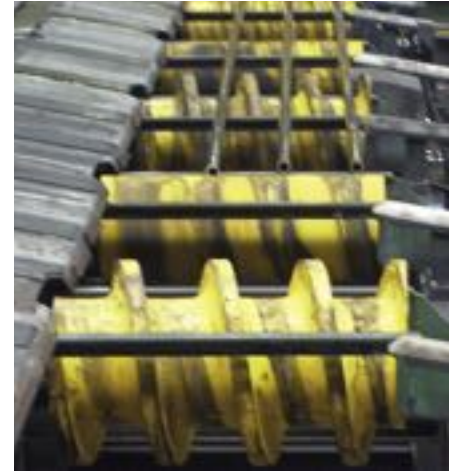

### secutex wipers

#### Wipers for steel bars

In the production of pipes and steel bars, so-called wipers are used for cleaning. The wipers have a round or rectangular outer profile and an inner profile that matches the shape of the object to be cleaned. Normally, several wipers are mounted in series, whereby the pass-through openings are smaller than the profile. The bar is pushed through the elastomer plates at high velocity, and the rubbery material strips the surface free from grease and cleaning fluid residues.

#### It is the edge that counts!

Just like a car window wiper, it is the edge that counts. Normally, the wipers are stamped from sheet goods. During stamping, the elastomer becomes distorted; the inner edge is therefore not dimensionally stable and is at an angle. Only part of the edge wipes emulsions from the surfaces depends on the profiles. This edge is rapidly worn down; the cleaning action is then unsatisfactory.

#### Streak-free cleaning

In collaboration with a renowned pipe manufacturer, secutex has developed a new wiper whose optimised wiper edge cleans a rough surface without leaving streaks. The secutex wipers are cast from moulds; the stamping process is done away with. The edge is perfectly formed and lies in complete contact with the pipes and steel bars passing through it.

#### Long service life

Users report the excellent durability of the secutex wipers; premature wear and material decomposition have not been observed. Thanks to the excellent service life, set-up times and downtimes could be significantly reduced.

### Technical execution for rolls

<b>surface</b>	<b>smooth</b>	polished	fabric	
<b>surface hardness</b>	55° Shore A	75° Shore A	90° Shore A	
<b>Inserts</b>	without insert	with perforated plate		
<b>coating form</b>	cylindrical	crowned	conical	according to the customer's drawing
<b>Sizes</b>	Length: 1800 mm	ø: 350 mm	Strength: from 3 mm	special sizes upon request
<b>Roll core</b>	available upon request			

